

1	Product Drawing				1 EA	
	DESCRIPTION		MAT'L	COLOR	Q'TY	REMARKS
	DESIGNED	CHECKED	THIRD ANGLE PROJECTION	SCALE: 1:1	END USE: 2026.01.20	
	K. S. LEE	S. H. LEE		UNIT: mm	RELATIONAL DWG NO:	
ECO DEVICE				TITLE EDLTL32LED-AC-28N		DWG NO

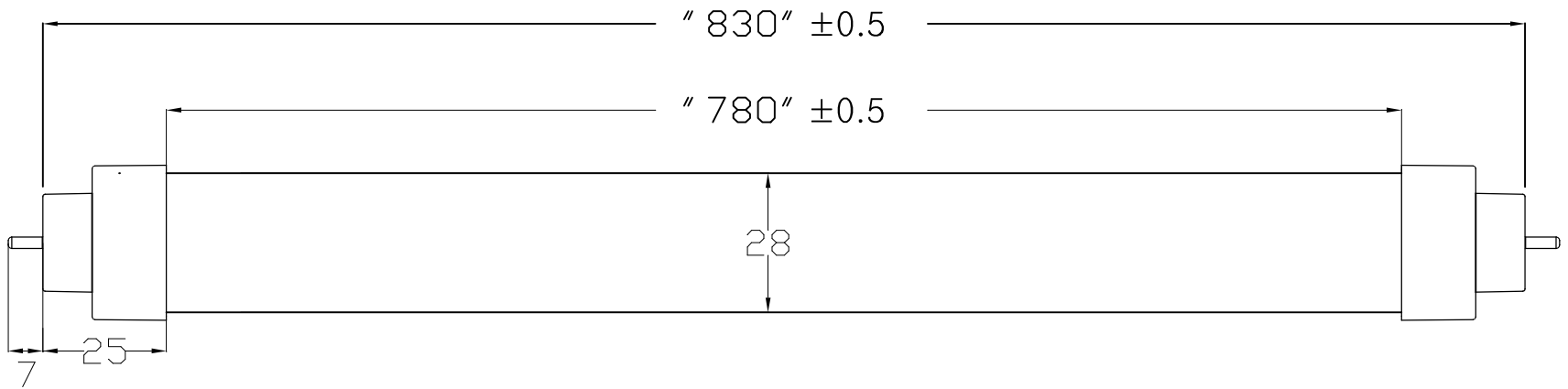
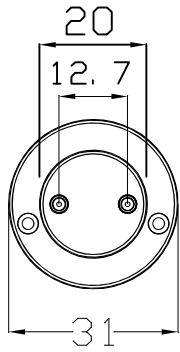

1	Product Drawing				1 EA	
	DESCRIPTION		MAT'L	COLOR	Q'TY	REMARKS
	DESIGNED	CHECKED	THIRD ANGLE PROJECTION	SCALE: 1:1	END USE: 2026.01.20	
	K. S. LEE	S. H. LEE		UNIT: mm	RELATIONAL DWG NO:	
ECO DEVICE				TITLE EDLTL32LED-AC-28W		DWG NO