

1	Product Drawing			1 EA	
	DESCRIPTION		MAT'L	COLOR	Q'TY
	DESIGNED	CHECKED	THIRD ANGLE PROJECTION	SCALE: 1:1	END USE: 2026.01.21
	K. S. LEE	S. H. LEE		UNIT: mm	RELATIONAL DWG NO:
ECO DEVICE			TITLE		DWG NO
			EFML27LED-N		

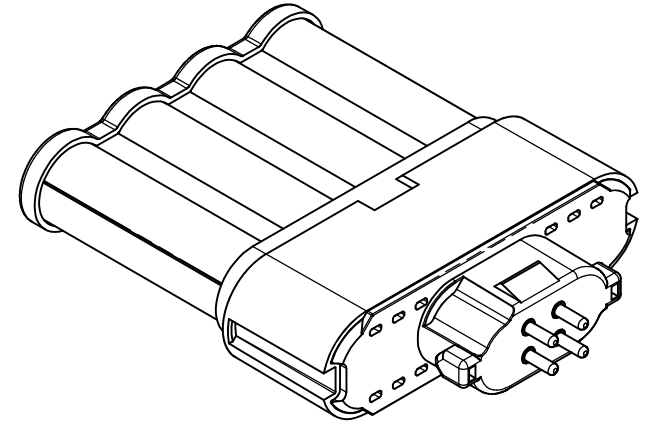
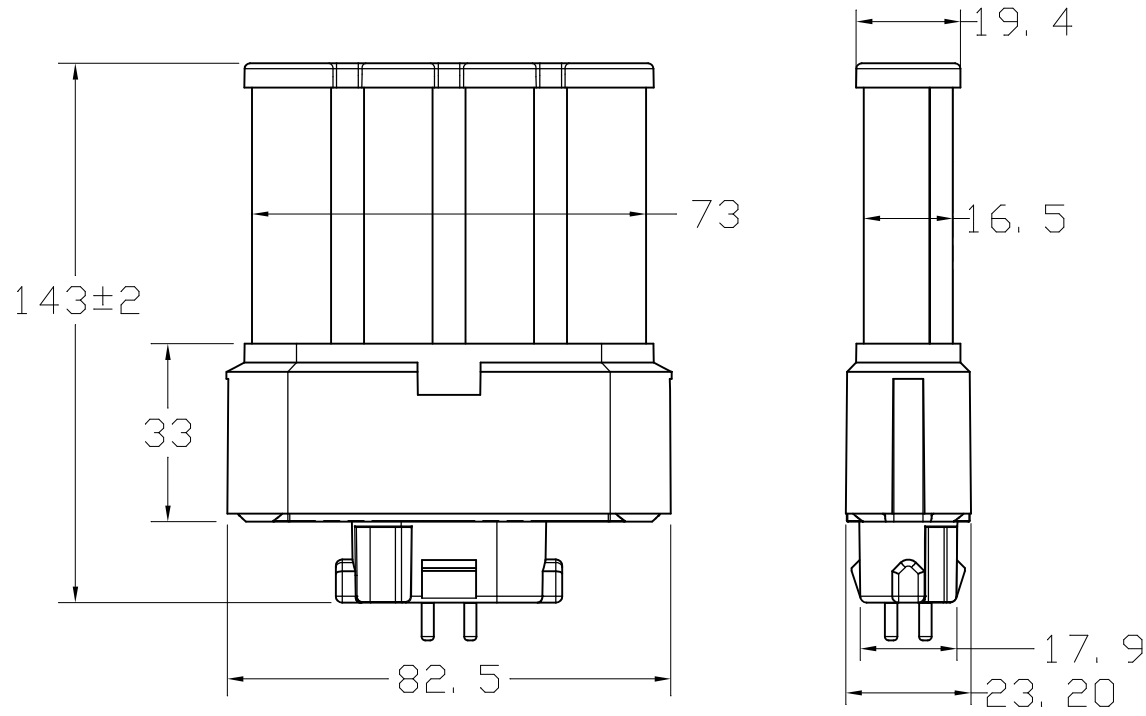

1	Product Drawing			1 EA	
	DESCRIPTION		MAT'L	COLOR	Q'TY
	DESIGNED	CHECKED	THIRD ANGLE PROJECTION	SCALE: 1:1	END USE: 2026.01.21
	K. S. LEE	S. H. LEE		UNIT: mm	RELATIONAL DWG NO:
ECO DEVICE			TITLE		DWG NO
			EFML27LED-W		